

2-ARM WALL MOUNT SPOUT
WITH GRAND ESCUTCHEONS
B-PU-422-00

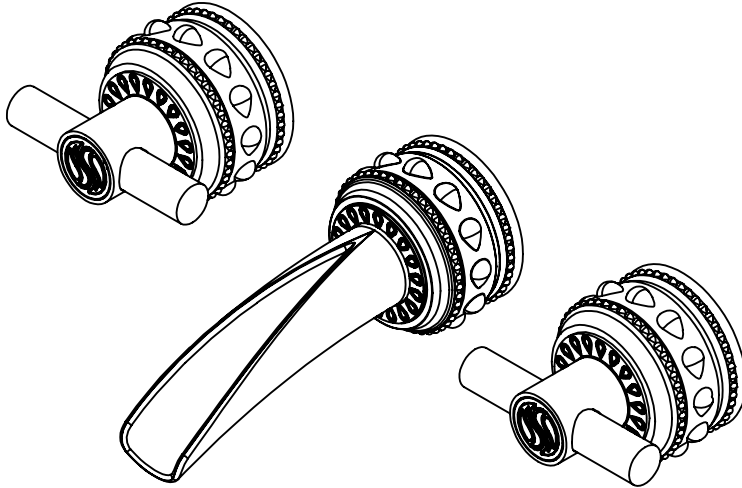

Custom Finishes

- AQUA MATTE BLACK
- AQUA POLISHED BLACK
- AQUA POLISHED GOLD
- AQUA MATTE ROSE GOLD
- AQUA POLISHED ROSE GOLD
- SOLACE NATURAL BRASS
- SOLACE BRONZE
- SOLACE AGED COPPER
- SOLACE AGED IRON
- SOLACE MATTE NICKEL
- SOLACE POLISHED NICKEL
- SOLACE AGED VERDE
- 22K MATTE GOLD
- 22K POLISHED GOLD
- 22K MATTE ROSE GOLD
- 22K POLISHED ROSE GOLD



- Solid brass construction for durability and reliability.
- Includes soft touch drain assembly.
- 20pt 1/4 turn ceramic disc valve cartridge.
- Standard aerator limited to 1.2 GPM.
- Compatible with other pieces from Susan Dunn Collections.
- Certified to meet or exceed the following codes and standards: ASME A112.18.1/CSAB 125.1-2012

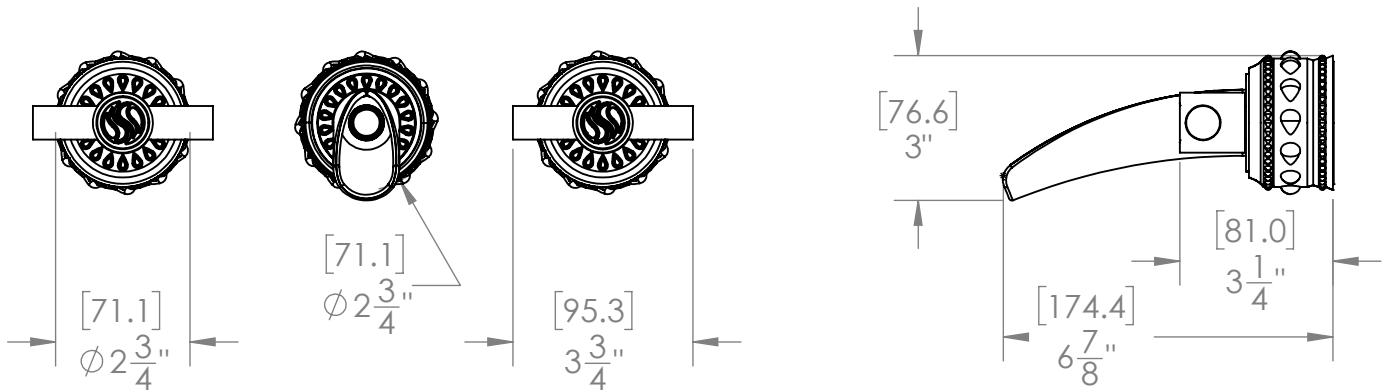

**2-ARM WALL MOUNT SPOUT
WITH GRAND ESCUTCHEONS**
B-PU-422-00

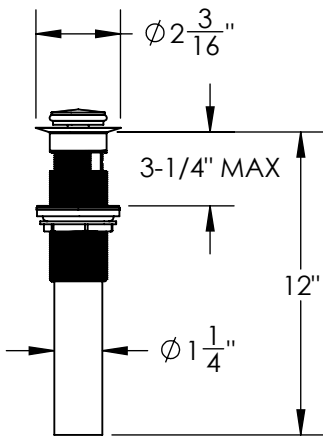
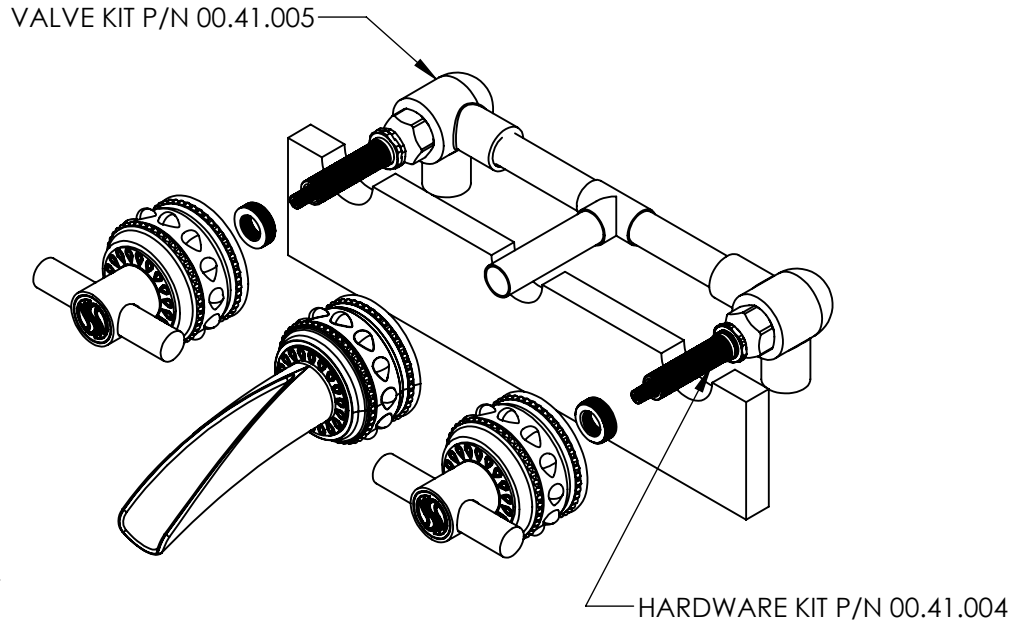

SOFT TOUCH
DRAIN ASSEMBLY
P/N 18.11.052

